



# SOFTSTARTER

## *HFR1000 SERIES*

15~315KW

## INSTRUCTION MANUAL



# PREFACE

*Thank you for your choice of EURA DRIVES SoftStarter.  
As the return of your trust we will provide the perfect quality and  
wholehearted service to you.*

Adopting modern control theory, modularization design, DSP controlled, high quality material and parts/components, together with advanced SMT manufacturing engineering, HFR1000 series softstarter is a high tech product combing digit, computer and modern automatic control theories. It is characteristic of high performance, high quality and skinny volume, and is widely applicable for starting and protection of three-phase motors in various industries.

## Notes

This instruction manual provides information with respects to installation, parameter-setting, trouble-diagnosing and proper operation. This manual should therefore be kept properly and a careful reading shall be required before any operation attempt to avoid any accidental casualties or damage(s) to the facilities.

### ★ Special Notice:

- ▲ Installation, operation, maintenance or checking to this product shall be required before reading carefully this instruction manual and ensuring proper use.
- ▲ Power shall be disconnected before any wiring. Never touch power terminal with hand or conduct object. Never put or drop

foreign substance into soft starter.

▲ When using the bypass contactor, please connect the motor according to the recommended diagram in the user's manual, that's in order to keep the output exact consistency of softstarter and motor. Otherwise softstarter and motor will be damaged.

▲ Connect input terminals R, S and T to urban power supply of 380V; connect output terminals U, V and W to motor.

▲ Grounding terminal PE  shall be properly earth connected (grounding impedance not exceeding  $4\Omega$ ).

▲ When terminals R, S and T are connected to power supply of 380V and output terminals U, V and W are not connected to motor, it is normal that the voltage of U, V and W is AC380V. The voltage is got by leakage current of module. After U, V and W are connected to motor, the voltage will clear away.

▲ Capacitance can not be connected to the output of soft starter, but capacitance can be connected to the input of soft starter when it is used for improving power factor.

# CONTENTS

1. Product Model and Consignee Check.....	1
2. Installation.....	3
3. Functional Block Diagram.....	6
4. Technical Parameters.....	7
5. Wiring.....	8
6. Setting.....	12
7. Function Chart.....	15
8. Function in Details.....	16
9. State Indication.....	22
Appendix 1. Maintenance.....	24
Appendix 2. Fault Diagnosis.....	25
Appendix 3. Application environment.....	27
Appendix 4. Modbus communication.....	28

# 1. Product Model and Consignee Check

Please check the product carefully according to the following steps after unpacking, please contact the supplier immediately if any problem is found.

 HFR1015 ————— HFR1055



 HFR1075 ————— HFR1200



☞ HFR1220 ————— HFR1315



## Standards for Product Design

- GB/T 12668.2 2002 Standard of rated value for low voltage AC frequency conversion electric drive system.
- GB/T 12668.3 2003 Standard and testing method of electromagnetism compatibility.

### 1.1 Nameplate Check

Model Illustration:

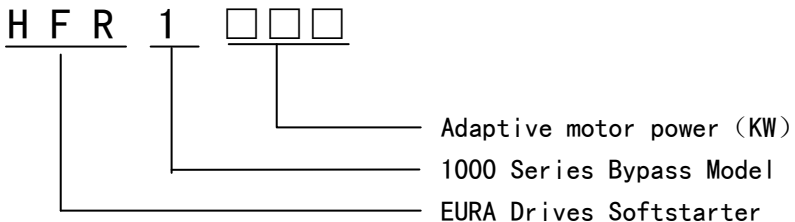

## **1.2 Product Check-up**

Product check-up is advised to be carried out to make sure whether damage(s) revived during transportation, such as depressed shell, distortion, loose connection with wiring or connected parts.

## **1.3 Unpacking Check-up**

Each soft starter has certificate of quality and user's manual. Please make sure whether the certificate and the manual are intact and conform to each other.

## **2. Installation**

For keeping a good product capability, the softstarter must be installed vertically. Installation space should strictly obey the following requirements. Good ventilation should be available to the installation environment, which should avoid direct sunlight for indoor installation.

Environment temperature:  $-10^{\circ}\text{C} \sim +50^{\circ}\text{C}$

Relative humidity:  $\leq 95\%$  ( $20^{\circ}\text{C} \pm 5^{\circ}\text{C}$ )

Environment conditions: Free from flammable gas, explosive gas and corrosive gas, free from electric dust, to be installed indoors with good ventilation.

Vibration below 0.5G

If the altitude is above 2000m, the capacity should be decreased accordingly for application.

## Structure Dimension: 15KW-55KW



## Structure Dimension: 75KW-315KW

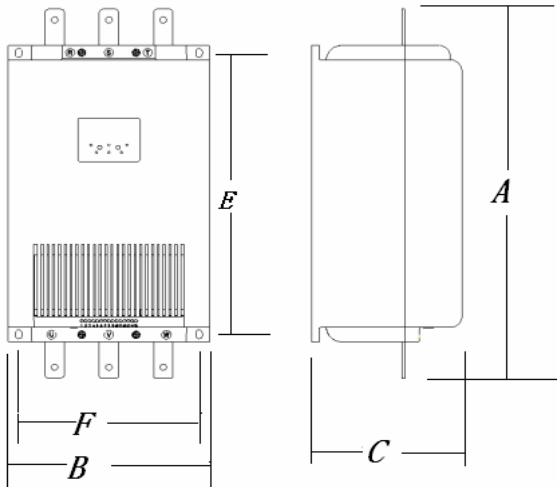



External Dimension (Unit: mm)

Model	A (High)	B(Wide)	C (Thick)
HFR1015 (15KW)	250	153	162
HFR1022 (22KW)	250	153	162
HFR1030 (30KW)	250	153	162
HFR1037 (37KW)	250	153	162
HFR1045 (45KW)	250	153	162
HFR1055 (55KW)	250	153	162
HFR1075 (75KW)	510	260	194
HFR1090 (90KW)	510	260	194
HFR1110 (110KW)	510	260	194
HFR1132 (132KW)	510	260	194
HFR1160 (160KW)	510	260	194
HFR1200 (200KW)	510	260	194
HFR1220 (220KW)	590	360	255
HFR1250 (250KW)	590	360	255
HFR1280 (280KW)	590	360	255
HFR1315 (315KW)	590	360	255

Installation Dimension (Unit: mm)

Model	E (High)	F(Wide)	Φ (Hole Dia)
HFR1015	219	140	Φ6
HFR1022	219	140	Φ6
HFR1030	219	140	Φ6
HFR1037	219	140	Φ6
HFR1045	219	140	Φ6
HFR1055	219	140	Φ6
HFR1075	389	232.5	Φ8.5
HFR1090	389	232.5	Φ8.5

HFR1110	389	232.5	Φ 8.5
HFR1132	389	232.5	Φ 8.5
HFR1160	389	232.5	Φ 8.5
HFR1200	389	232.5	Φ 8.5
HFR1220	560	300	Φ 8.5
HFR1250	560	300	Φ 8.5
HFR1280	560	300	Φ 8.5
HFR1315	560	300	Φ 8.5

**Note: HFR1015--HFR1200 soft starter with plastic housing, available in stock.**

**HFR1220--HFR1315 soft starter with metal housing, available in stock.**

### 3. Functional Block Diagram

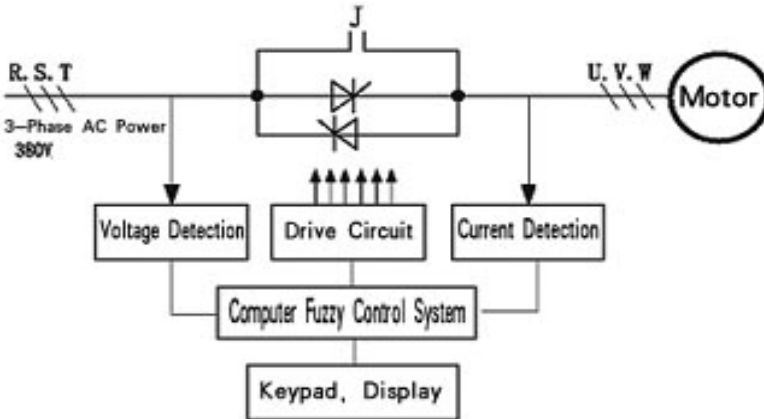

Three reverse-parallel connection SCR modules are adopted as power element. By picking up synchronization signal from input voltage sampling, it can pick up output current sampling for feedback fuzzy control, trace the phase automatically and control phase displacement angle. Voltage can thus be increased step by step, and startup current will be under control. After startup, the bypass contactor will make the SCR short circuit. The motor will finally be driven into the electricity network for operation.

## 4. Technical Parameters

Control power supply	AC 380V $\pm$ 20%, 50/60Hz (It is supplied by interior, users need not supply power.)
3-Phase power supply	AC 380V $\pm$ 20%, 50/60Hz
Nominal current	30A~630A, totaling 16 kinds rated currents
Motor power	15~315KW(rated voltage 380V)
Applicable motor	Common squirrel cage type asynchronism motor
Startup mode	Voltage ramp startup (1~120 seconds, adjustable); current limiting startup (150~400%, adjustable); voltage kick startup
Stop mode	Free stop; soft stop (1~60seconds , adjustable)
Relay output	Delay running output; fault output; full voltage output (by pass) [contact dot: 5A, 250VAC]
Startup frequency	for frequent or infrequent startup; Advise: not exceeding ten times per hour
Protection function	Phase loss of input, over-load, short circuit, over-heating, and etc.
Safety degree	IP20
Cooling mode	Cooling naturally
Installation mode	Hanging mode
Environment conditions	Environment temperature:-10 $^{\circ}$ C ~ +45 $^{\circ}$ C Relative humidity: $\leq$ 95%(20 $^{\circ}$ C $\pm$ 5 $^{\circ}$ C) Free from flammable gas, explosive gas and corrosive gas, free from electric dust, to be installed indoors with good ventilation Vibration below 0.5G If the altitude is above 2000m, the capacity should be decreased accordingly for application.

## 5. Wiring

### 5.1 Terminal Function

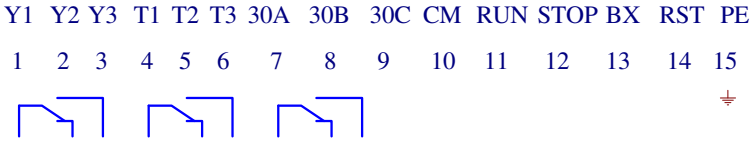

Terminal Number	Terminal Name	Description	Technical Parameters
1	Start-delay Signal	Y1: Middle terminal	AC250V5A
2	Start-delay Signal	Y2-Y1Normal close	AC250V5A
3	Start-delay Signal	Y3-Y1Normal open	AC250V5A
4	Bypass Signal	T1: Middle terminal	AC250V5A
5	Bypass Signal	T2-T1Normal close	AC250V5A
6	Bypass Signal	T3-T1Normal open	AC250V5A
7	Fault Signal	30A: Middle terminal	AC250V5A
8	Fault Signal	30B-30A Normal close	AC250V5A
9	Fault Signal	30C-30A Normal open	AC250V5A
10	Common Terminal	CM(External Common Terminal)	
11	Startup Signal	RUN-CM effective turn on	
12	Stop Signal	STOP-CM effective turn on	
13	Free stop Signal	BX-CM effective turn on	
14	Reset Signal	RST-CM effective turn on	
15	Function Ground -Terminal	PE—Ground	

## 5.2 Basic Wiring Diagram

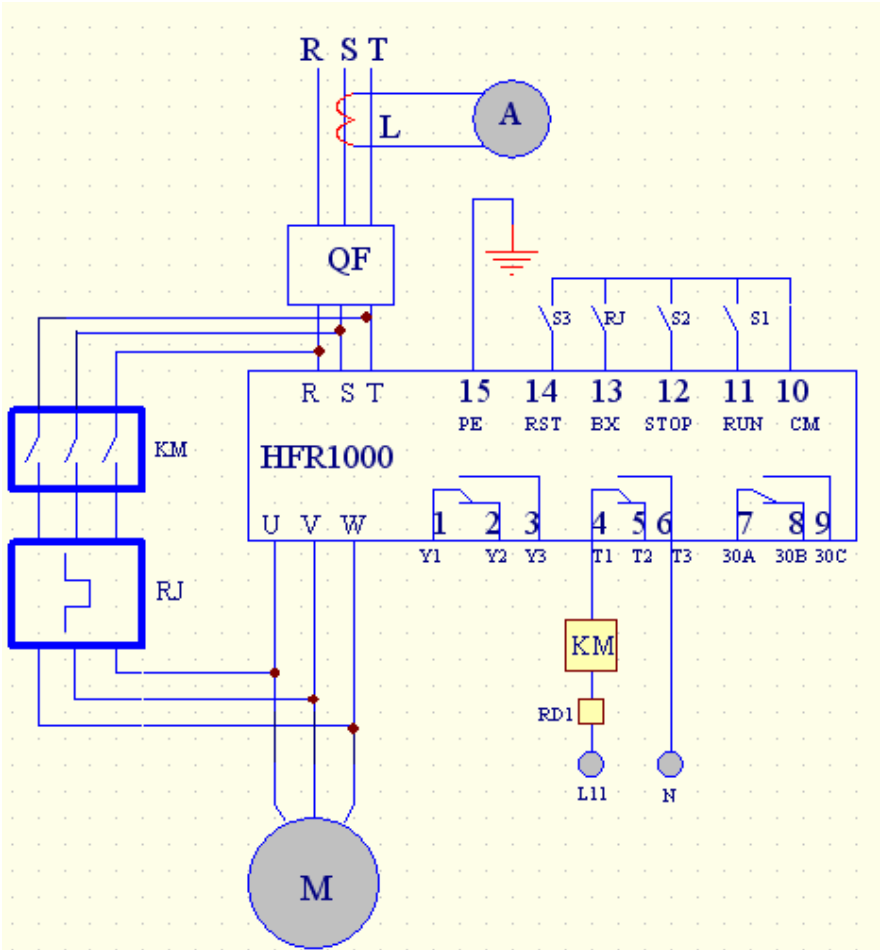

R, S, T terminals of softstarter are input terminals while U, V, W are output terminals. QF-auto air breaker, KM-contactor, RJ-over heating protection relay, RD1-fuse, L11—N is connected to 220V. And L11-N is forbidden being connecting to 380V.

## 5.3 Recommended Wiring Diagram

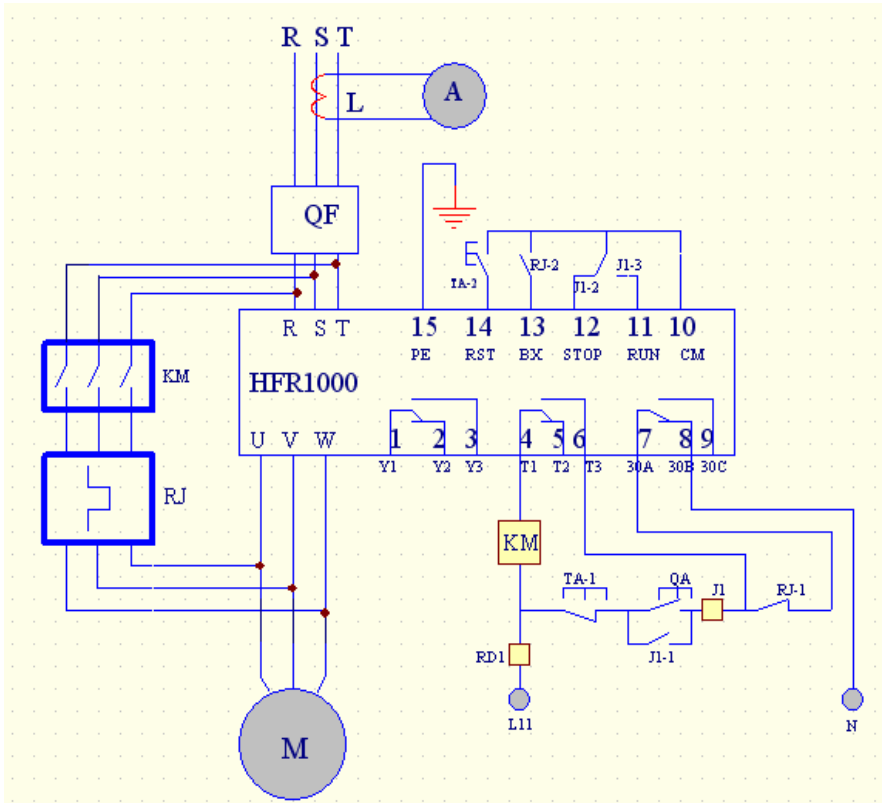

!PE Grounding wire should be as short as possible, and should be connected to the nearest grounding point, better on the installation board against the soft starter. Installation board should also be grounded.

! Please connect motor with the phase-sequence recommended by manual. Correctly connect softstarter output with bypass contactor. Otherwise softstarter and motor will be ruined.

! Suggestion: adding a group of resistor-condenser on contactor winding can absorb the voltage pinnacle.

### Controlling Loop:







User can select to use bypass contactor. It can be switched to bypass circuit running automatically. To select this operation mode, an AC contactor should be fixed (to be ordered separately)

## 5.4 Optional Parts

Adaptable Motor(KW)	Model	Rated Current (A)	Contactora Model (optional)	Wiring (MM <sup>2</sup> )
15	HFR1015	30	CJX4-50	10
22	HFR1022	45	CJX4-50	10
30	HFR1030	60	CJX4-80	16
37	HFR1037	76	CJX4-80	16
45	HFR1045	90	CJX4-95	25
55	HFR1055	110	CJX4-115F	25
75	HFR1075	150	CJX4-150F	35
90	HFR1090	180	CJX4-185F	35
110	HFR1110	218	CJX4-225F	50
132	HFR1132	260	CJX4-265F	60
160	HFR1160	320	CJX4-330F	75
200	HFR1200	400	CJX4-500F	90
220	HFR1220	440	CJX4-500F	90
250	HFR1250	500	CJX4-630F	150
280	HFR1280	560	CJX4-630F	150
315	HFR1315	630	CJX4-630F	150

## 6. Setting

### Keypad Panel

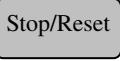
Keys	Name of Keys	<p>Note</p> <p>The following is the operation instruction of keypad panel.</p>  <p style="text-align: center;">Fig 1-1 keypad panel</p>
	“mode” key	Control box displays function code “HF××”. The current and “stop” key switch to each other.
	“set” key	To be used with “mode” key. Under the “HF××” display state, press “set” key, the control box will display the corresponding value of function code. Press “up” and “down” key to change its value, and then press “set” to save the changed value.
	“up” key	Under “HF××” display state, press “up”, “down” key to select other function code. After enter the function code, they are used to change the value of the function code.
	“down” key	
	“run” key	Press “run” key for startup.
	“stop/reset” key	Under any state, press “stop/reset” key, it will have priority to be valid. Press twice for free stop of the softstarter. And it also can reset the softstarter when malfunction happens.



## Special Display Content and Interpretation

Display Items	Interpretation
—HF—	Show reset process; under single control mode, it displays such content after reset normally;
RUN	Startup state
STOP	Stop state
OUT	Run state
SST	Soft-stop state
DEL_	Startup interval status (it is displayed in the startup interval)
Count Down	Delay state

Main adjustable parameters: Startup torque compensation  
 Ramp ascending time  
 Soft-stop time (ramp descending time)  
 Startup current limited

Startup mode: Voltage ramp soft startup  
 Current limiting soft startup  
 Kick soft startup

Stop mode: Voltage ramp soft stop mode  
 Free stop mode

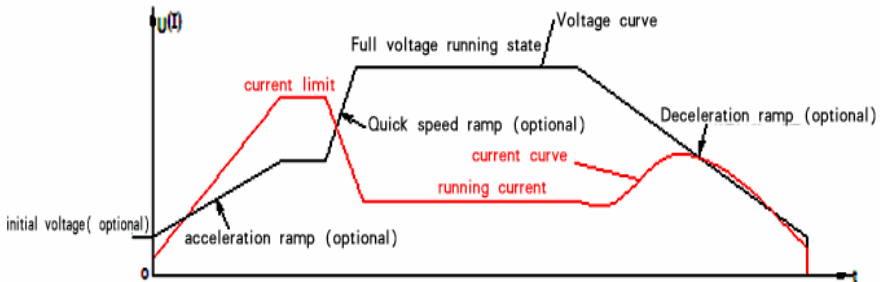

Soft Startup/Soft Stop Voltage (Current) Feature Curve

## 6.1 Initial Voltage Setting (U0)

Initial voltage for startup (0--50%)Ue, stepless adjustable.

Initial voltage for kick startup, voltage (20%-80%) Ue, stepless adjustable.

## 6.2 Startup Ramp Time Setting

Ramp ascending time: 1-120S, adjustable.

## 6.3 Stop Ramp Time Setting

Ramp descending time:1-60S, adjustable.

## 6.4 Startup Current Limit

Startup current (1.5~4) Ie : stepless adjustable. (As the data sets, the biggest startup current will be limited in this range)

 The above parameters should be set when the starter is not working! Under the startup, soft-stop and full-voltage working state, all the parameter-settings will not be effective.

## 7. Softstarter Function Chart

Function No.	Function Explanation	Data Explanation	Mfr Value
HF00	Control mode	0 Keypad control 1 External terminal control / keypad control	1
HF01	Startup mode	0 Voltage ramp startup 1 Current limit startup 2 Kick startup	1
HF02	Startup delay time	0-600S	0S
HF03	Stop mode	0 Free stop    1 Soft stop	0
HF04	Torque compensation	0-50% rated voltage	5%
HF05	Kick voltage	20-80% rated voltage	50%
HF06	Kick time	1-60S	2S
HF07	Ramp ascending time	1-120S	20S
HF08	Ramp descending time	1-60S	20S
HF09	Startup current limit	150-400% rated current	300%
HF10	Startup time interval	1-3600S	240S
HF11	Data initialization	0 No action 1 Action (manufacturer value restored)	0
HF12	Fault memory 1	Present fault	0
HF13	Fault memory 2	The last fault	0
HF14	Fault memory 3	Previous two faults	0
HF15	Fault memory elimination	0 No Action    1 Action	0
HF16	PC protection selection	0 Invalid    1 Valid	1
HF17	Voltage ramp OL coefficient	0-60	0
HF18	Stop bits	0 One    1 Two	0
HF19	Parity check	0 Odd    1 Even    2 No check	0
HF20	Communication baud rate	0: 1200 1: 2400 2: 4800 3: 9600 4: 19200	2
HF21	Communication Address	1-127: Softstarter address	1

HF22	Selection of ASCII mode and RTU mode	0 ASCII mode 1 RTU mode	0
HF23	Motor power	15-315KW	Subject to inverter model
HF24	Close loop Control mode	0 Close loop mode 1 1 Close loop mode 2	0
HF30	Software Edition No.		Mfir's value
HF25-HF29, HF31	Reserved (Don not change)		Mfir's value

## 8. Function in Details

HF00	Control mode	0 Keypad control 1 External terminal control / keypad control	1
------	--------------	--	---

Control mode selection can be operated directly through the panel keypad, and can also be done by external terminal control. The manufacturer value is 1.

HF01	Startup mode	0 Voltage ramp startup 1 Current limit startup 2 Kick startup	1
------	--------------	---	---

You can start by selecting one of the following three modes:  
0 Voltage ramp startup, 1 current limit startup, 2 kick startup, manufacturer value is 1

Δ Voltage ramp startup  
Set HF01 to 0, and set ramp startup time  $t$  (HF07) and torque compensation voltage (HF04)  $U_0$ , the motor will start along with the increasing input voltage, and the speed will accelerate accordingly till its top speed, as shown in Fig1.

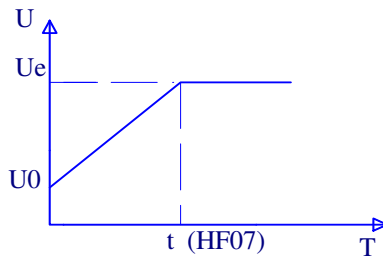

Fig1 Voltage Ramp Startup Feature Curve

Δ Current limit startup

Set HF01 to 1 and set startup current limit percent  $I_s$  (HF09) and Torque compensation voltage (HF04). The current of the motor will increase until the voltage ramp reaches  $I_s$ , then it will stop, and the speed will accelerate to its full speed. After that, the current will decrease to below the rated current  $I_e$ , as shown in Fig2:

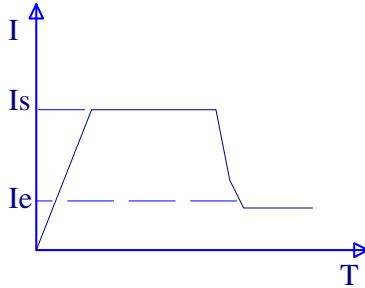

Fig2 Current Limit Startup Feature Curve

Δ Kick startup

Set HF01 to 2, and set ramp start time  $t$  (HF07) and torque compensation (HF04), kick time  $t$  (HF06). The motor will start rapidly along with the increasing voltage, then the voltage will increase in a ramp way, and the speed will accelerate to its full speed. It is better for startup motor with big inertia, as shown in Fig3:

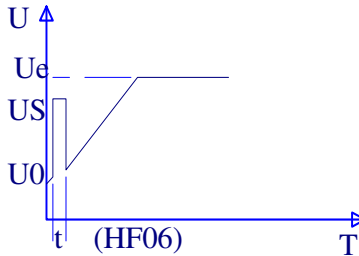

Fig3 Kick Startup Feature Curve

HF02	Startup delay time	0-600S	0S
------	--------------------	--------	----

Startup delay time is set for startup preparation, and the motor will not start in this interval. Count down mode is used for display, and the time can be set from 0 to 600 seconds. And it will output a normal open –normal close contact dot signal. By applying the signal, a warning signal may be effected for safety attention! The manufacturer value is set to 0S

HF03	Free stop	0 Free stop 1 Soft stop	0
------	-----------	-------------------------	---

You can stop by selecting two modes: 0 free stop 1 soft stop. The manufacturer value is set to 0.

Free stop means that the voltage of softstarter will reduce directly from  $U_e$  to 0V, and the motor will run with inertia till its stop, as shown in Fig4:

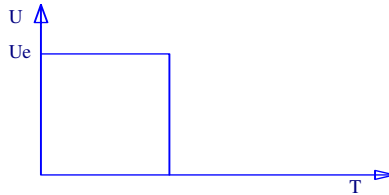

Fig4 Free Stop Feature Curve

Soft stop means that the voltage of starter will reduce gradually from  $U_e$  to 0V when the voltage drops. The soft stop can help resist “water hammer domino effect”, as shown in Fig5:

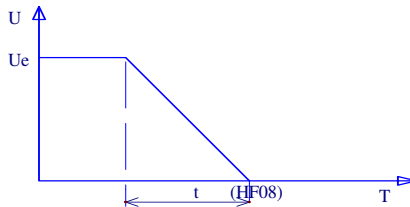

Fig5 Soft Stop Feature Curve

HF04	Torque compensation	0-50% rated voltage	5%
------	---------------------	---------------------	----

Torque compensation means to adjust the torque produced by initial voltage  $U_0$ . The manufacturer value is set to 5%. If the load is heavy, please increase HF04. It is valid in the voltage ramp startup and current limit startup.

HF05	Kick voltage	20-100% rated voltage	50%
------	--------------	-----------------------	-----

As for a load with big static torque, an instant high voltage must be inflicted, so that it can start smoothly with the torque big enough, the “kick voltage” range is from 20% to 80% percent of the rated voltage. The manufacturer value is set to 50% rated voltage.

HF06	Kick time	1-60S	2S
------	-----------	-------	----

Kick time means the interval to exert high voltage, adjustable between 1-60S. The manufacturer value is set to 2S.

HF07	Ramp ascending time	1-120S	20S
------	---------------------	--------	-----

Ramp ascending time means the interval to bring the voltage from 0V up to rated voltage  $U_e$ . The manufacturer value is set to 20S.

HF08	Ramp descending time	1-180S	20S
------	----------------------	--------	-----

Ramp descending time means the interval to bring the voltage from rated voltage  $U_e$  to 0V. The manufacturer value is set to 20S.

HF09	Startup current limit	150-400% rated current	300%
------	-----------------------	------------------------	------

It works when HF01 is set to 1, startup current limit = HF09\* $I_e$ , please adjust HF09 for a successful start, less current is preferred.

HF10	Startup interval	1-3600S	240S
------	------------------	---------	------

This equipment is small-sized, and you can only restart it when the radiator cools down from the previous startup, otherwise the machine will stop due to over-heating protection. The startup interval is adjustable, and no more than 10 startups per hour are preferred for full load startups. The manufacturer value is set to 240S.

HF11	Data initialization	0 no action	0
		1 action (manufacturer value is restored)	

When the data is in disorder, please restore the manufacturer value by setting data initialization 1.

HF12	Fault memory 1	Present fault	0
------	----------------	---------------	---

Store and display the code for present fault, for example 0: no fault, 1: means OH overheating fault, 2: means OC over current fault, 3: means PF phase loss, 4: means OL over load or jam fault.

HF13	Fault memory 2	Last fault	0
------	----------------	------------	---

Store and display code of last fault, for example 0: no fault, 1: means OH overheating fault, 2: means OC over current fault, 3: means PF phase loss, 4: means OL over load or jam fault.

HF14	Fault memory 3	Previous two faults	0
------	----------------	---------------------	---

Store and display the code of fault before last, for example 0: no fault, 1: means OH overheating fault, 2: means OC over current fault, 3: means PF phase loss, 4: means OL over load or jam fault.

HF15	Fault memory elimination	0 no action 1 action	0
------	--------------------------	-------------------------	---

When HF15 is set to 1, all present fault codes, code of last fault and the code of previous two faults will be eliminated, and the display will be 0. When HF15 is set to 0, the program will be renewed automatically after each fault occurs. The manufacturer value is 0.

HF16	PC protection selection	0 invalid 1 valid	1
------	-------------------------	-------------------	---

When HF16 is set to 1, the function is valid. It is used to protect motor and softstarter.

HF17	Voltage ramp OL coefficient	0-60	0
------	-----------------------------	------	---

Set overload time protection coefficient in the voltage ramp startup. When OL malfunction occurs in the voltage ramp startup, please increase this parameter.

HF18	Stop bits	0 one 1 two	0
------	-----------	-------------	---

Set numbers of stop bits. The manufacturer value is 1.

Note: please choose one stop bit when parity check is enable; when parity check is null, two stop bits are chosen.



HF19	Parity check	0 Odd 1 Even 2 No check	0
------	--------------	-------------------------	---

Set the mode of Parity check. The manufacturer value is set to Odd check.

HF20	Communication baud rate	0: 1200      1: 2400 2: 4800      3: 9600 4: 19200	2
------	-------------------------	--	---

Set the communication baud rate. The manufacturer value is 4800.

HF21	Communication Address	1-127: Softstarter address	1
------	-----------------------	----------------------------	---

Set softstarter address. The manufacturer value is 1.

HF22	Selection of ASCII mode and RTU mode	0 ASCII mode 1 RTU mode	0
------	--------------------------------------	----------------------------	---

Set communication mode. The manufacturer value is set to ASCII mode.

HF23	Motor power	15-315KW	Subject to inverter model
------	-------------	----------	---------------------------

Motor power setting is applied for current display warp revising and setting current limited value. The manufacturer value is subject to inverter model.

HF24	Close loop Control mode	0 Close loop mode 1 1 Close loop mode 2	0
------	-------------------------	--	---

When HF24=0, close loop mode 1 is selected, when HF24=1, close loop mode 2 is selected. The close loop mode 1 is fit for most loads, but centrifugal fan or other big inertia load will cause the unsteady starting. The close loop mode 2 is recommended for this situation.

HF30	Software Edition No.		Mfr's value
------	----------------------	--	-------------

HF30 will display the Edition No. of software. User can only check it.

HF25-HF29, HF31	Reserved (Do not change)		Mfr's value
--------------------	--------------------------	--	-------------

## 9. State Indication

### 9.1 Fault Indication

Protection function	Display in the panel	Counter measures
Over current	OC1/OC2	Please decrease HF04 and increase HF07 in the voltage ramp startup. Please refer to Appendix 2 in the current limited startup.
Out-phase	P.F.	Please check if power input is normal.
Overheat	OH	Please check softstarter installation environment and improve ventilation; please decrease startup times if startup is frequent. When the temperature fell into the safe range, OH protection stops.
Over load	OL	Please increase HF17 and HF07 in the voltage ramp startup, please increase HF09 in the current limited startup.
PC protection	PC	If softstarter is switched into bypass within 1S during the starting process, "PC" malfunction will display. Please increase HF07 and decrease HF09. If softstarter runs alone without load, "PC" malfunction will display. If the power of motor and softstarter has a great difference, "PC" will display because starting process is too fast. Please match the right power of softstarter.

The rest trouble shooting refers to Appendix 2.

### 9.2 Current Display

During the debugging process, press the mode key. When the startup is finished, and it works with full voltage, it can be examined by external current mutual inductor, with ammeter display.

## 9.4 Indicator Display

Indicator state	Soft starter state	Explanation
RUN○ FWD● DGT● FRQ●	Running state	Light is on in-running state after startup finished, and light is off in standby state.
RUN● FWD○ DGT● FRQ●	Delay state	Light is on when delay begins , and light is off when delay ended.
RUN● FWD● DGT○ FRQ●	External control state	Light is on when external control works, and light is off in keypad state.
RUN● FWD● DGT● FRQ○	Current display	Light is on, and current is displayed when press MODE key during the startup process; light goes off when press it again, and state is displayed.

“○” indicates the light is on, “●” indicates the light is off.

## Appendix 1. Maintenance



**Be sure the power of soft starter is turned off, before you start any maintenance and checkup !**

- Please check the cooling channel of soft starter regularly, make sure it isn't blocked by trash and dust.
- Keep and install soft starter in a place far from strong eroding, high powder, high temperature or high humidity. Soft starter should avoid strong vibration.
- Clean it regularly and check whether it works properly.
- Check input wire and output wire of soft starter regularly. Check whether the grounded wire is reliable, and whether terminals become flexible.
- Renew startup contact implement (relay) regularly.
- Check whether there is imprint or parts damage caused by overheating.
- Check whether the wire is aging.

**Note:** When soft starter breaks down or doesn't work properly, please handle it according to this manual; Contact the manufacturer when you fail to solve the problems. Users are not allowed for any repair by themselves.

## Appendix 2. Fault Diagnosis

Problems	State explanation	Troubleshooting
Motor sounds buzz, when power is on	Soft starter is in standby state	<ol style="list-style-type: none"> <li>1. Check whether the bypass contactor is blocked at the closed place;</li> <li>2. Check whether the silicon controlled rectifier (SCR) is spark-through or damaged.</li> </ol>
Motor can not work normally with the startup signal input.		<ol style="list-style-type: none"> <li>1. In external control state, check whether the terminal RUN-CM is turned on;</li> <li>2. Check whether the control circuit connection is right, control switch works normally.</li> </ol>
	No control power supply state	<ol style="list-style-type: none"> <li>1. Check whether work voltage is normal.</li> </ol>
	Wrong parameter set	<ol style="list-style-type: none"> <li>1. Check every parameter set value one by one, make sure that the set values match the practical parameters of motor;</li> <li>2. Check the current limit value</li> </ol>
	Phase loss occurs during startup	Check three phases' voltage, judge whether there is phase loss and eliminate fault
	Wire connection of motor is open	<ol style="list-style-type: none"> <li>1. Check whether the connection of output terminals of soft starter and what of motor is right and reliable;</li> <li>2. Check the input terminals' voltage, judge whether internal circuit of motor is open;</li> <li>3. Check whether there is phase loss in input terminal</li> </ol>
Startup current exceeds the set value	Current limit function fails	<ol style="list-style-type: none"> <li>1. Check whether the startup current set is right;</li> <li>2. Check whether the connection of current mutual inductor is right;</li> <li>3. Check whether the current mutual inductor works properly, and matches the motor.</li> </ol>
	Environment temperature is too high	<ol style="list-style-type: none"> <li>1. Check whether soft starter installation environment has good ventilation and is installed vertically;</li> <li>2. Check whether soft starter avoids direct sunlight successfully;</li> </ol>
	Over run current of	<ol style="list-style-type: none"> <li>1. Check whether the soft starter has short circuit in output connection ;</li> </ol>

	motor	<ol style="list-style-type: none"><li>2. Check whether overload of motor or damage happens;</li><li>3. Check whether phase loss fault happens in the motor.</li></ol>
	Soft starter is short circuit between input and output terminal connection	<ol style="list-style-type: none"><li>1. Check whether the bypass contactor is blocked at the closed place;</li><li>2. Check whether the silicon controlled rectifier (SCR) is sparked through or damaged</li></ol>



**The above problems must be handled by professionals. Users are not allowed for any repair by themselves.**

## Appendix 3. Application environment (for reference)

Machinery type	Load type	Startup mode		Parameters setting		Startup time (S)	
		Voltage Ramp	Current limited	Torque (%)	Current (%)		
Water pump	Standard load		•	10%	300%	10	30
Fan	A little heave load	•		20%		10	30
compressor (piston-type)	Standard load		•	10%	350%	10	30
compressor (centrifugal)	Standard load	•		15%		10	30
Convey	Standard load		•	10%	300%	10	30
Mixer	A little heave load		•	15%	350%	20	40
Ball crusher	Heavy load	•		30%		30	60
Muller	Heavy load		•	30%	400%	30	60

Users can set the parameters according to actual load.

To a little heavy load and heavy load, the manufacturer recommend user to choose higher power of softstarter. For example: centrifugal fan, mixer, ball crusher and muller. If the load starts frequently (ten times with one hour), please choose higher power of softstarter. Furthermore, the startup mode of “Kick startup” is recommended for heavy load and heavy inertia.

# Appendix 4 Communication Manual

(Modbus Version 1.5)

## I. General

Modbus is a serial and asynchronous communication protocol. Modbus protocol is a general language applied to PLC and other controlling units. This protocol has defined an information structure which can be identified and used by a controlling unit regardless of whatever network they are transmitted.

Modbus protocol does not require a special interface while a typical physical interface is RS485.

**You can read reference books or ask for the details of MODBUS from manufactures.**

## II. Modbus Protocol

### 1. Overall Description

#### (1) Transmission mode

##### 1) ASCII Mode

When controllers are setup to communicate on a Modbus network using ASCII mode, each 8-bit byte in a message is sent as two ASCII characters. For example, 31H (hexadecimal data) include two ASCII characters '3(33H)', '1(31H)'.

Common characters, ASCII characters are shown in the following table:

Characters	'0'	'1'	'2'	'3'	'4'	'5'	'6'	'7'
ASCII Code	30H	31H	32H	33H	34H	35H	36H	37H
Characters	'8'	'9'	'A'	'B'	'C'	'D'	'E'	'F'
ASCII Code	38H	39H	41H	42H	43H	44H	45H	46H

##### 2) RTU Mode

In RTU mode, one Byte is expressed by hexadecimal format. For example, 31H is delivered to data packet.

#### (2) Baud rate

Setting range: 1200, 2400, 4800, 9600, 19200

#### (3) Frame structure:

##### 1) ASCII mode

Byte	Function
1	Start Bit (Low Level)
7	Data Bit
0/1	Parity Check Bit (None for this bit in case of no checking. Otherwise 1 bit)
1/2	Stop Bit (1 bit in case of checking, otherwise 2 bits)



2) RTU mode

Byte	Function
1	Start Bit (Low Level)
8	Data Bit
0/1	Parity Check Bit (None for this bit in case of no checking. Otherwise 1 bit)
1/2	Stop Bit (1 bit in case of checking, otherwise 2 bits)

(4) Error Check

1) ASCII mode

**Longitudinal Redundancy Check (LRC):** It is performed on the ASCII message field contents excluding the 'colon' character that begins the message, and excluding the CRLF pair at the end of the message.

The LRC is calculated by adding together successive 8-bit bytes of the message, discarding any carries, and then two's complementing the result.

A procedure for generating an LRC is:

1. Add all bytes in the message, excluding the starting 'colon' and ending CRLF. Add them into an 8-bit field, so that carries will be discarded.
2. Subtract the final field value from FF hex (all 1's), to produce the ones-complement.
3. Add 1 to produce the twos-complement.

2) RTU Mode

**Cyclical Redundancy Check (CRC):** The CRC field is two bytes, containing a 16-bit binary value. The CRC is started by first preloading a 16-bit register to all 1's. Then a process begins of applying successive 8-bit bytes of the message to the current contents of the register. Only the eight bits of data in each character are used for generating the CRC. Start and stop bits, and the parity bit, do not apply to the CRC.

A procedure for generating a CRC-16 is:

1. Load a 16-bit register with FFFF hex (all 1's). Call this the CRC register.
2. Exclusive OR the first 8-bit byte of the message with the high-order byte of the 16-bit CRC register, putting the result in the CRC register.
3. Shift the CRC register one bit to the right (toward the LSB), zero-filling the MSB. Extract and examine the LSB.
4. (If the LSB was 0): Repeat Step 3 (another shift).
- (If the LSB was 1): Exclusive OR the CRC register with the polynomial value A001 hex (1010 0000 0000 0001).
5. Repeat Steps 3 and 4 until 8 shifts have been performed. When this is done, a complete 8-bit byte will have been processed.

When the CRC is appended to the message, the low-order byte is appended first, followed by the high-order byte.

2. **Command Type & Format**

(1) The listing below shows the function codes.

code	name	description
03	Read Holding Registers	Read the binary contents of holding registers in the slave. (Less than 10 registers once time )
06	Preset Single Register	Preset a value into holding register

(2) Format

1) ASCII mode

Start	Address	Function	Data				LRC check		End	
: (0X3A)	Inverter Address	Function Code	Data Length	Data 1	...	Data N	High-order byte of LRC	Low-order byte of LRC	Return (0X0D)	Line Feed (0X0A)

2) RTU mode

Start	Address	Function	Data	CRC check		End
T1-T2-T3-T4	Inverter Address	Function Code	N data	Low-order byte of CRC	High-order byte of CRC	T1-T2-T3-T4

3) Protocol Converter

It is easy to turn a RTU command into an ASCII command followed by the lists:

- 1) Use the LRC replacing the CRC.
- 2) Transform each byte in RTU command into a corresponding two byte ASCII. For example: transform 0x03 into 0x30, 0x33 (ASCII code for 0 and ASCII code for 3).
- 3) Add a 'colon' ( : ) character (ASCII 3A hex) at the beginning of the message.
- 4) End with a 'carriage return – line feed' (CRLF) pair (ASCII 0D and 0A hex).

So we will introduce RTU Mode in followed part. If you use ASCII mode, you can use the up lists to convert.

(3) Address and meaning

The part introduces inverter running, inverter status and related parameters setting.

**Description of rules of function codes parameters address:**

1) Use the function code as parameter address

1. General Series:

High-order byte: 01~09 (hexadecimal)

Low-order byte: 00~3C

For example: F114 (display on the board), parameter address is 010E (hexadecimal).

2. Softstarter series

High-order byte: 00

Low-order byte: 00~3C

For example: HF14 (display on the board), parameter address is 000E (hexadecimal).

Note: in this situation, it allows to read six function codes and write only one function code.

Some function codes can only be checked but cannot be modified; some function codes can neither be checked nor be modified; some function codes can not be modified in run state; some function codes can not be modified both in stop and run state.

In case parameters of all function codes are changed, the effective range, unit and related instructions shall refer to user manual of related series of inverters. Otherwise, unexpected results may occur.

2) Use different parameters as parameter address

(The above address and parameters descriptions are in hexadecimal format, for example, the decimal digit 4096 is represented by hexadecimal 1000).

**1. Running status parameters**

Parameters Address	Parameter Description (read only)
1001	The following is softstarter status. The high-order byte is 0, and low-order byte is the status of softstarter. 0. standby 1. running 2. OC1 protection 3. OC2 protection 4. PF protection 5. OH protection 6. OL protection
1002	Output current

**2. Control commands**

Parameters Address	Parameters Description (write only)
2000	Command meaning: 0003: Deceleration stop 0004: Free stop 0008: Run (no directions) 0009: Fault reset

**3. Communication parameters**

Parameters Address	Parameters Description (read only)
3000	Command meaning: 0000: no error 0001: illegal function 0002: illegal address 0003: illegal parameters 0004: LRC error 0005: CRC error 0006: system locked

**4. Response**

Command Description	Parameters Description
Response when reading parameters	1、 return code value in normal response 2、 not allowed to read return FFFF(hex)
Response when writing parameters	0001: operate successfully 0002: less than min value 0003: greater than max value 0004: not allowed to change 0005: in fault status 0006: system locked

The following is response command when read/write parameters:

Eg1: In RTU mode, change acc time (F007) to 10.0s in NO.01 softstarter.

Host Query

Address	Function	Register Address Hi	Register Address Lo	Preset Data Hi	Preset Data Lo	CRC Lo	CRC Hi
01	06	F0	07	00	0A	8B	0C

Function code F007 Value: 10.0S

Slave Response

Address	Function	Register Address Hi	Register Address Lo	Response Data Hi	Response Data Lo	CRC Lo	CRC Hi
01	06	F0	07	00	04	0A	C8

Function code F007 Do not allow to change

Eg 2: Read status and output voltage from N0.2 softstarter.

Host Query

Address	Function	First Register Address Hi	First Register Address Lo	Register count Hi	Register count L0	CRC Lo	CRC Hi
02	03	10	00	00	02	C0	F8

Communication Parameters Address 1000H

Slave Response:

Address	Function	Byte Count	Data Hi	Data Lo	Data Hi	Data Lo	Crc Lo	Crc Hi
02	03	04	00	02	00	00	68	F3

OC1 protection output current

Eg 3: NO.1 softstarter runs forwardly.

Host Query:

Address	Function	Register Hi	Register Lo	Write status Hi	Write status Lo	CRC Lo	CRC Hi
01	06	20	00	00	01	43	CA

Communication parameters address 2000H Forward running

Slave Response:

Address	Function	Register Hi	Register Lo	Write status Hi	Write status Lo	CRC Lo	CRC Hi
01	06	20	00	00	01	43	CA

Writing parameters successfully

Eg4: Read the value of F017 from NO.2 softstarter

Host Query:

Address	Function	Register Address Hi	Register Address Lo	Register Count Hi	Register Count Lo	CRC Lo	CRC Hi
02	03	F0	11	00	01	E7	3C

Communication Parameter Address F011H

Reading one Register.

Slave Response:

Address	Function	Register Address Hi	Register Address Lo	Read status Hi	Read status Lo	CRC Lo	CRC Hi
02	03	F0	11	00	04	27	3F

The actual value is 4.

### 3. **Additional Remarks**

(1) Expressions during communication course:

Parameter Values of Current=actual value X 10

Others parameter Values=actual value X 1

Parameter value is the value sent in the data package. Actual value is the actual value of inverter. After PC/PLC receives the parameter value, it will divide the corresponding coefficient to get the actual value.

NOTE: Take no account of radix point of the data in the data package when PC/PLC transmits command to inverter.. The valid value is range from 0 to 65535.

### III **Function codes related to communication**

Function Code	Name	Setting Rang	Mfr's Value
HF18	Stop bit	0 one bit 1 two bits	0
HF19	Parity Check	0:Odd 1:Even 2:No checkout	0
HF20	Baud Rate	0 1200 1 2400 2 4800 3 9600 4 19200	2
HF21	Soft starter's Address	1-127	1
HF22	ASCII and RTU mode Selection	0 ASCII Mode 1 RTU Mode	0

You can read device status and function code value or preset functions value of soft starter regardless of value of HF00.

Please set functions code related to communication consonant with the PLC/PC communication parameters, when soft starter communicate with PLC/PC.

#### IV physical interface

1 interface

Hardware uses communication MAX485, the following are the pin of 485 interface.

VCC: 5V power supply

GND: ground of 5V

Connect A+ to A+ of PLC or other converter and connect A - to B- of PLC or other Converter, when soft starter communicate to other devices.

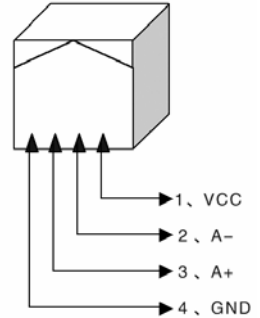

2 Structure of Field Bus

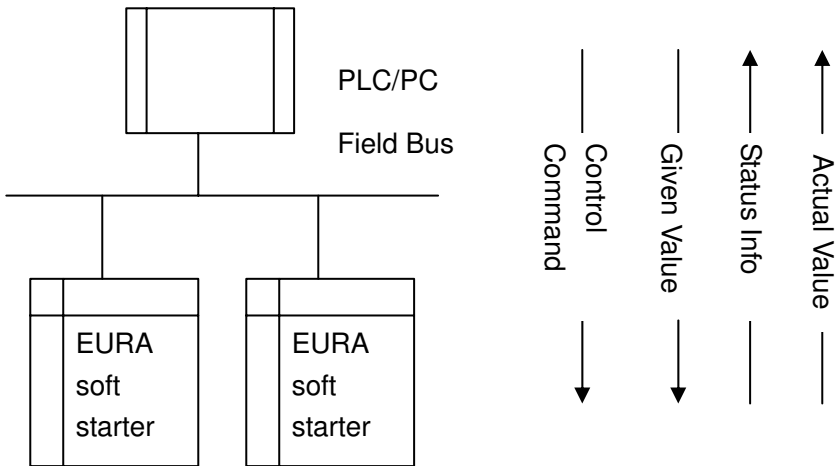

Connecting Diagram of Field Bus

RS485 Half-duplex communication mode is adopted for EURA softstarter.

Daisy chain the devices together. Do not use 'spur' lines, or a star configuration. Terminating Resistors of 120 Ohms should be used on the ends of long modbus/485 loops. In the first example below, the terminator should be placed at the PLC and modbus device 4.

**Correct**

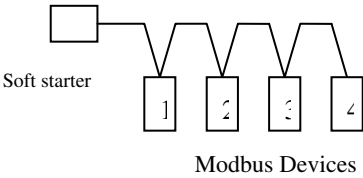

**Wrong**

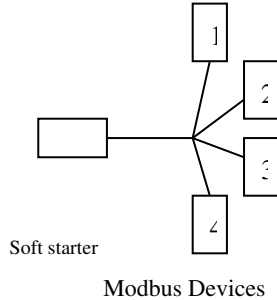

**Wrong**

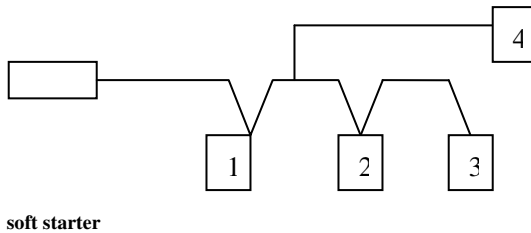

Modbus Devices

Please note that for the same time in half-duplex connection, only one inverter can have communication with PC/PLC. Should two or more than two inverters upload data at the same time, then bus competition will occur, which will not only lead to communication failure, but higher current to certain elements as well.

No direct grounding shall be allowed for any point of RS485 network. All the equipment in the network shall be well grounded via their own grounding terminal. Please note that grounding wires will not form closed loop in any case.

Please think over the drive capacity of PC/PLC and the distance between PC/PLC and inverter when wiring. Add a repeaters if drive capacity is not enough. Modbus repeaters may be used to extend the length of the loop, but introduce delay in the device response time. Using repeaters on slow devices may cause timeout problems.



All wiring connections for installation shall have to be made when the inverter is disconnected from power supply.